

italveneta[®]
didattica
a better play



Who we are

Italveneta Didattica is an Italian company that, since **1978**, boasts extensive experience in the design and production of **certified and high quality toys** for public places like schools, kindergartens, parks, hotels, restaurants, and tourist facilities.

Our quality

Located in the province of Venice, we combine craftsmanship with **advanced technology**, creating toys appreciated for their **innovative design** and robustness. Moreover, we are strongly committed to environmental sustainability, with an **eco-friendly line** made with recycled materials. We offer a **wide range of products**, including large indoor and outdoor games, educational games, furniture, sports equipment, and motor skills, as well as polystyrene and plexiglass shapes for hobbies.

Our services

Our attention to detail and customer service is reflected in our ability to offer prompt delivery and exceptional **after-sales service**. The replacement of individual parts even after years makes our games a **sustainable choice**. With Italveneta Didattica, every game becomes a story to live and an **opportunity of growth** for children, ensuring parents the peace of mind knowing their children are playing in a safe and well-designed environment.





Our facilities

With over 40 years of experience, Italveneta stands out as a **producer of certified, high-quality toys**. Our production area of 1,000 square meters uses **advanced molding technologies**: rotational, blow molding, and injection molding. Our offices and warehouses, covering 3,000 square meters, ensure efficient order management. This organization allows us to offer flexibility and immediate availability while always maintaining the **high quality** that distinguishes us.

Italveneta Didattica is synonymous with Italian products, safety, and quality.



What is our commitment?

Mission

We design and produce certified, high-quality toys, creating **safe and stimulating environments** for children to encourage exploration, learning, and growth.

We guarantee the highest safety of our **Made in Italy products**, ensuring parents' satisfaction.

Vision

We want to see the world **through child's eyes**, transforming play into an adventure and an opportunity for growth. We aspire to become a reference point in the industry, combining **craftsmanship and innovation** to create experiences that inspire creativity, discovery, and joy, contributing to the **healthy development** of children.

Our story

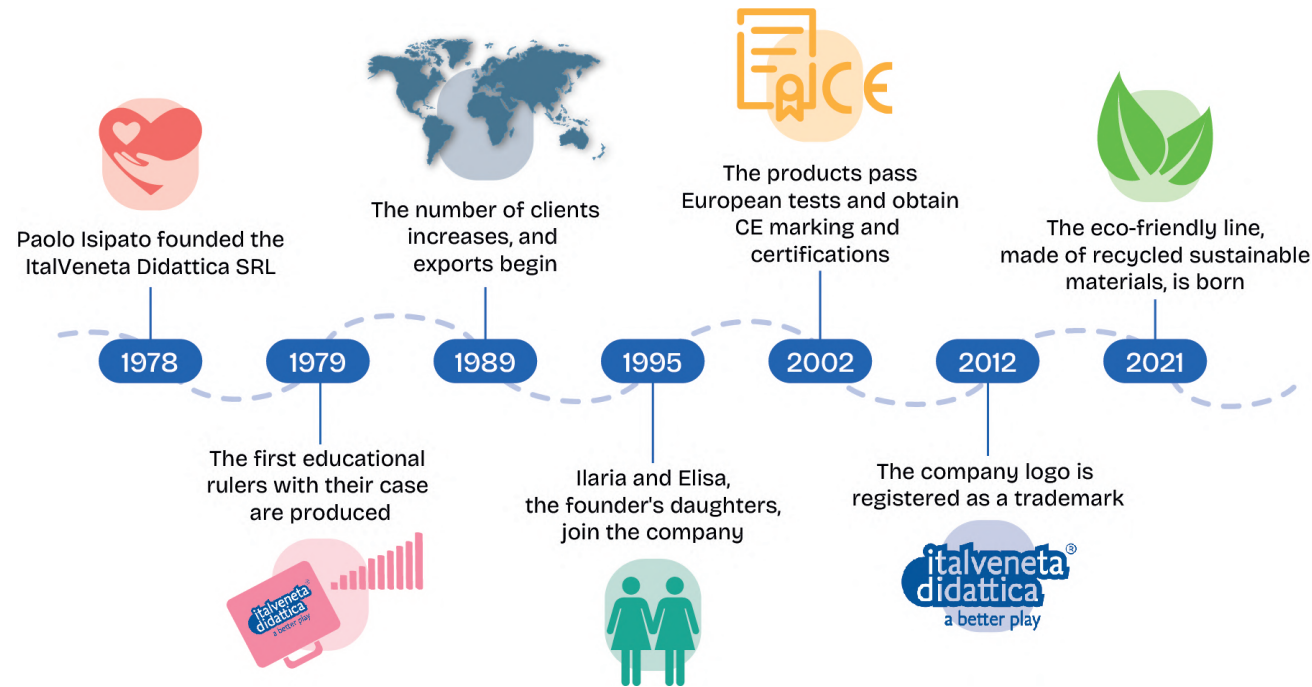

Value

- Safety**
Priority to the protection of children with rigorous international certifications.
- Quality**
Production of Made in Italy games, durable and reliable.
- Innovation**
Combination of artisanal production and advanced technologies.
- Sustainability**
Sustainable games with replaceable parts and an eco-friendly line.
- Service**
Excellent after-sales service, with prompt delivery and continuous support.
- Creativity**
Games that contribute to children's cognitive and social development.

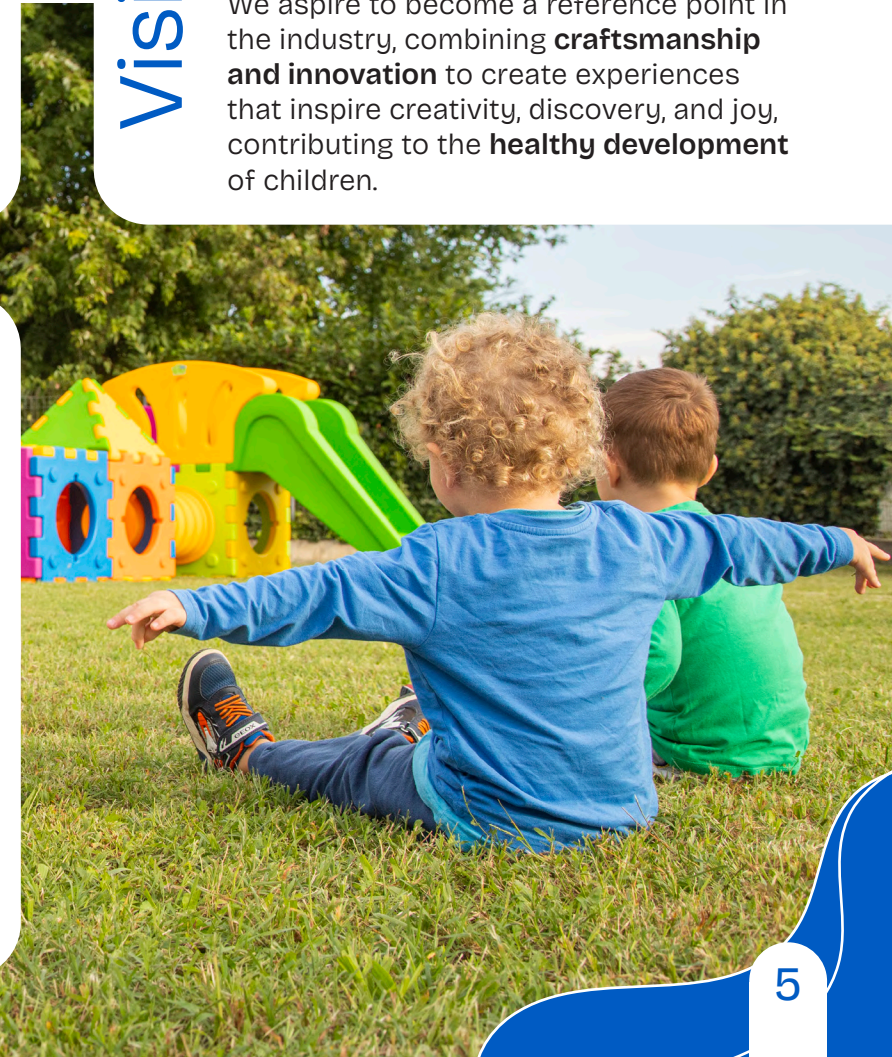

Reviews from our clients

EP

Astreja

Italveneta Didattica is a **professional and reliable partner**. Communication is good, orders **on time as agreed**, high quality items. We recommend them as a partner!



MA

Markus

Italveneta Didattica is a **great company to work with**, as a wholesaler. I can always count on their certified and high quality products, **fast delivery** and customer service. They produce a **wide range of items** and I'm completely satisfied with all of them.



EK

Ekaterina

We have been cooperating with Italveneta for many years. Products of **high Italian quality, bright colors, convenience and safety** of using such simple, but such necessary sports items. All our customers who purchase Italveneta products always speak **only good words** about the goods. We are always satisfied with the **speed of production** of our order, service and trouble-free fulfillment of all our requests and wishes! We hope for a long and profitable cooperation for many more years.



italveneta
didattica
a better play



Why Are Certifications Important?



Children **learn about the world** and social interaction through play. It is essential that the games they spend their days with at home, in kindergartens, or schools are safe and do not cause them harm.

Italveneta Didattica toys are **100% safe** as they have passed rigorous tests conducted by international certification bodies that guarantee their total safety, ensuring a consistently **reliable product**.

CE Free circulation Directive 2009_48_CE

It establishes safety standards for toys and their free circulation within the European Community, applying to products intended for children under 14 years old. It defines the responsibilities of manufacturers, importers, and distributors, specifies CE marking to indicate compliance with regulatory requirements, and introduces obligations regarding warnings and legal markings.

Mechanical and Physical Requirements

UNI EN 71-1

It establishes requirements and test methods for the mechanical and physical properties of toys. Tests examine materials, edges, points, cords, and more, considering the duration and normal or foreseeable conditions of use, as well as the usual behavior of children.

Flammability Tests

UNI EN 71-2

It specifies flammability requirements for toys. The tests verify that the product does not contain prohibited flammable materials and defines flammability requirements for certain toys when exposed to a small flame source.

Chemical Requirements

UNI EN 71-3 and 71-9

It establishes the requirements and testing methods for the migration of certain chemical elements (antimony, arsenic, barium, cadmium, chromium, lead, mercury, and selenium) from the materials that make up the toys. The tests verify the chemical properties of the product, excluding non-accessible materials

Equipments and Playground toys safety

UNI EN 1176-1 and 1176-3

They establish general safety requirements and test methods for swings, slides and playground equipment, and similar activity toys, for both indoor and outdoor use. The tests verify the general safety provisions for these types of toys.

Furniture safety

UNI EN 1729-1, 1729-2 and
UNI EN 1730-6.3/6.5/6.6/6.7

They specify the functional dimensions, safety requirements, and test methods for furniture, chairs, and tables intended for educational institutions. The tests verify aspects such as vertical static load, vertical fatigue, vertical impact, and stability with vertical load.

Play Areas

Durable

Made from **high-quality plastic**, these large play structures are designed to **withstand all weather conditions** and heavy use. They maintain **bright colors** and stable structure even under sun, rain, snow, wind, and sand, ensuring long-lasting durability and safety.

Easy

Cleaning is simple and only requires **water and mild soap**, with no need for special products. Assembly is **quick and intuitive** thanks to **interlocking systems**, allowing structures to be set up and taken down easily without complex tools.

Versatile

Our play structures **blend into any setting**, from public parks to indoor spaces, adapting seamlessly to schools, tourist facilities, gardens, and recreational areas. Their **modular design** allows optimal configuration to make the most of any available space.



Index

Eco-friendly

Sustainable products made with **recycled materials** to promote environmental respect. Ideal for those who want to combine play and sustainability.

- Cones and Stilts
- Hoops e Clips
- Giant Blocks
- Fencing



page 12

Playground toys

Large equipment for **indoor and outdoor use**, designed to ensure fun and safety for children in large spaces.

- Wagon toy
- Cubic toy
- Replacement elements



page 16

Furniture

Functional and colorful furnishing solutions, designed to create **welcoming and safe environments**, suitable for various needs.

- Flooring
- Fencing
- Covers
- Chairs
- Tables
- Cots



page 28

Psychomotricity

Products that promote the development of **motor skills** in children through games and pathways that stimulate **movement and coordination**.

- Trolleys and Containers
- Sponge Items
- Soccer goal
- Stilts, Hoops, Poles, and Clips
- Obstacles, Cones, and Markers
- Motor Skills Kits and Courses
- Gym Accessories



page 36

Recreational activities

Games and equipment for free time, designed to **stimulate creativity and fun**, and to promote playful activities both indoors and outdoors.

- Manipulative Beads
- Bricks
- Sand Toys
- Road Signs



page 58

Educational

Educational materials that support learning and the development of children's **logical and mathematical skills** through practical and interactive tools.

- Counting Rods
- Logical Figures
- Abacus



page 66

Hobby

Products for DIY and creative activities, ideal for DIY projects that **stimulate the manual skills** and imagination of children and adults.

- Crystal
- Polystyrene



page 70

Eco-friendly



CONES

High-quality cones made of recycled material, with **cross-shaped grooves** at the top for inserting poles or hoops, and **symmetrically drilled holes** on the sides for inserting poles at the desired height.



ART. 7064

Cone 12 holes
h 30 cm

ART. 7069

Cone 12 holes
h 50 cm



light
green



brown
purple



UNI EN
71-1/2/3
CE

CERTIFICATION

STILTS

The stilts from the eco-sustainable line, made of recycled material, **develop motor coordination of arms and legs**. The **serrated top part** improves foot grip, and the adjustable cords adapt to the child's height. They are available with **anti-slip rubber**, inserted in the lower part, to play safely and quietly.

ART. 7141

Pair of stilts WITH
anti-slip rubber

ART. 7142

Pair of stilts WITHOUT
anti-slip rubber



dark
orange



brown



UNI EN
71-1/2/3
CE

CERTIFICATION

GIANT BLOCKS

The giant block from the eco-sustainable line is made of recycled plastic material, safe and durable. Easily assembleable, it enhances children's psychomotor activities and promotes creativity through a design that facilitates the insertion of hoops and poles, ideal for giant constructions.



ART. 7008

GIANT BLOCKS
SET 40 pieces

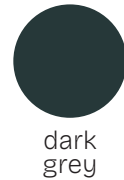

dark grey

ART. 7019

GIANT BLOCKS
SET 20 pieces



brown

CLIPS

Universal joints made of recycled plastic material for connecting poles and hoops of various sections (25 mm o 30 mm).



ART. 7110

CLIP
support
jolly



ART. 7111

CLIP
pole-pole
rotating



ART. 7112

CLIP
pole-flat hoop
rotating



dark orange



brown



dark grey

UNI EN
1176-1
CERTIFICATION

FENCINGS

The eco-sustainable line of modular panels offers a stable and solid structure ideal for creating fully enclosed play spaces or delimiting areas, both for indoor and outdoor use. Made with high-quality and non-toxic material, the panels have rounded shapes and a perfect and simple interlocking system that keeps them steady without the need for anchoring when positioned in a line.



ART. 0200MARR

Play pen
• 4 panels (110x5x60h)
• 4 bases
Total length 4,40 m



brown

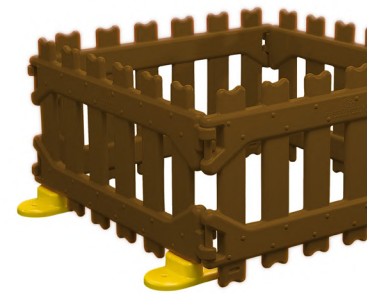

CERTIFICATION
UNI EN
71-1/2/3
CE

HOOPS

NYLON HOOPS flat section

Durable hoops made of high-quality flexible recycled material, with memory shape, meaning they immediately return to their original shape.

ART. 7081

Flat hoop Ø30 cm

ART. 7082

Flat hoop Ø40 cm

ART. 7083

Flat hoop Ø50 cm

ART. 7084

Flat hoop Ø60 cm

ART. 7085

Flat hoop Ø65 cm

ART. 7086

Flat hoop Ø70 cm



light green

ART. 7087

Flat hoop Ø80 cm

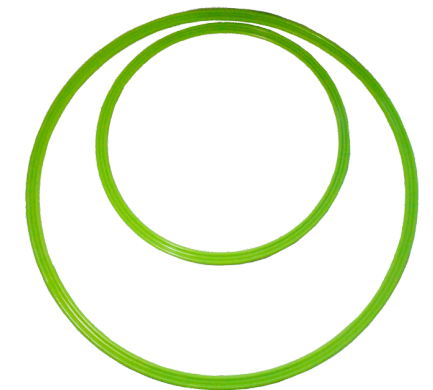

Playground toys



WAGON TOY

Wagon Toy is a playground modular toy with **interlocking elements**, easy to assemble, sturdy, and reliable.

Available in vibrant colors and **resistant to weather** conditions, it has a **secure base** that makes it stable on any surface and ensures the safety of children. The side windows allow **excellent illumination** inside the wide tunnel, and the wagons allow the creation of fun and varied paths.



UNI EN
71-1/2/3
CE
CERTIFICATION



FEATURES

- **Safety** of the base and the hooking system that prevent involuntary opening
- **Capacity** up to 250 kg (approximately 10 children)
- **Durable colour** to weather conditions
- **Easy to assemble** thanks to the modular elements
- **Internal illumination** provided by side windows
- **Versatility** in creating different paths.



WAGON TOY

UNI EN
71-1/2/3
CE
CERTIFICATION

WAGON TOY



ART. WT5

MODEL A - BASE SET

- 3 wagons interlocking
- 2 ends

Total length 200 cm



ART. WT3

EXTENSION C

3 wagons



ART. WT2

EXTENSION D

2 wagons



ART. WT7

MODEL B - 5 WAGONS SET

- 5 wagons interlocking
- 2 ends

Total length 324 cm



ART. WT10

8 WAGON SET

- 8 wagons interlocking
- 2 ends

Total length 524 cm

Various configurable paths

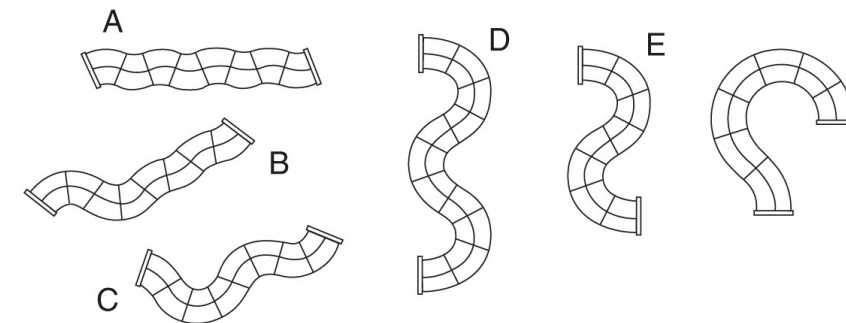

Stable support
base



CUBIC TOY

Cubic Toy is an innovative modular game that allows building miniature cities and playgrounds, stimulating children's imagination and creativity.

Made of sturdy non-toxic plastic, it offers endless combination possibilities thanks to its easily assemblable elements.

Moreover, to ensure safety, the maximum height does not exceed 1.5 meters, thus complying with current regulations.



CERTIFICATION
UNI EN
1176-1/3

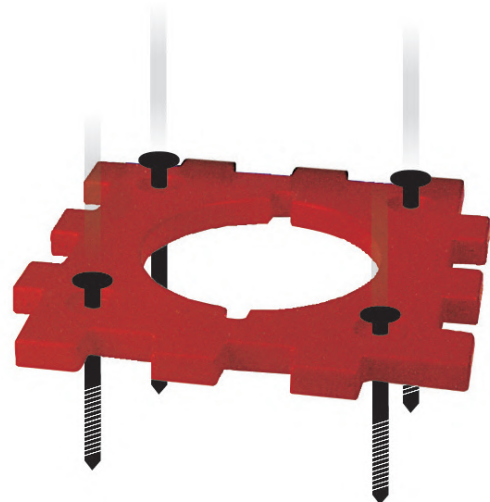

Possibility to anchor the panel to the ground with long expansion screws

FEATURES

- **Modularity** of elements to create cubes, houses, bridges, and other structures
- **Quality materials** resistant to UV rays and weather conditions
- Suitable for playareas, gyms, and pools
- **Safety** verified for accessibility, installation, and maintenance
- **Lightweight**, easy to transport and assemble
- Vibrant, durable and bright colors
- Possibility to **continuously expand constructions** with new pieces.

CUBIC TOY

CERTIFICATION
UNI EN
1176-1/3

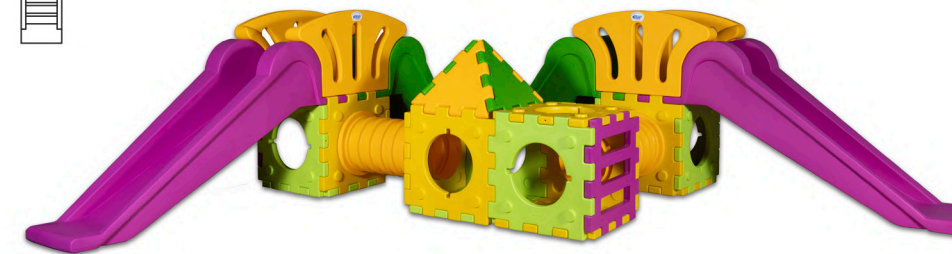
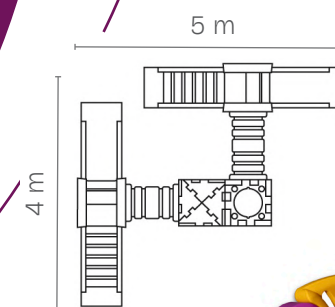

ART. 301

G2000

- 17 panels
- 2 ladder panels
- 2 large slides
- 2 large stairways
- 2 tunnels
- 4 protective sides
- 4 triangles
- 1 top section

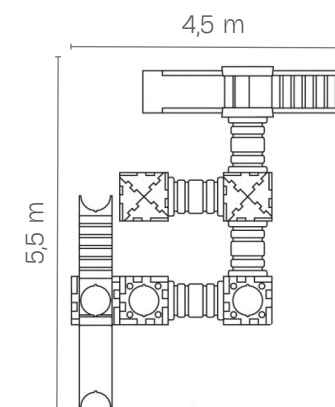

ART. 302

M2000

- 29 panels
- 2 ladder panels
- 1 large slide
- 1 large stairway
- 2 step-slides
- 4 tunnels
- 2 protective sides
- 8 triangles
- 1 top section

CUBIC TOY

ART. 158

I2000

- 13 panels
- 2 ladder panels
- 1 large stairway
- 8 triangles
- 2 protective sides
- 1 large slide
- 2 tunnels

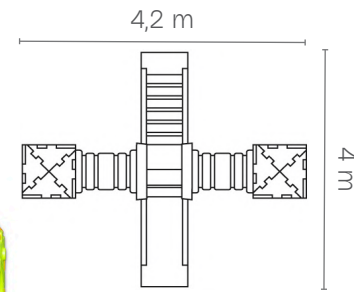
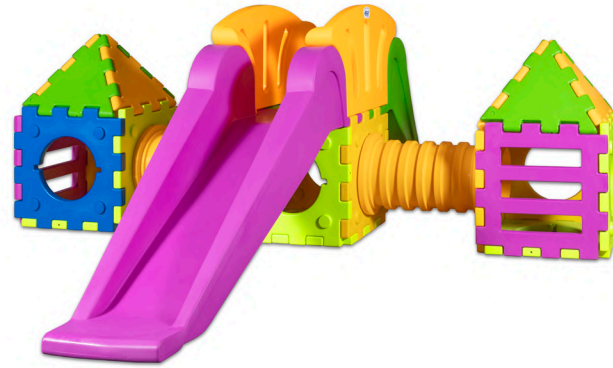

ART. 159

L2000

- 9 panels
- 1 large stairway
- 2 protective sides
- 2 ladder panels
- 1 large slide
- 1 tunnel

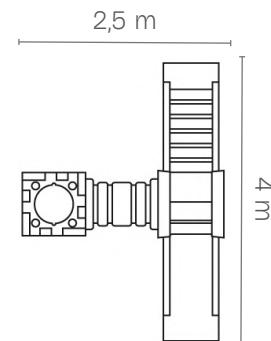
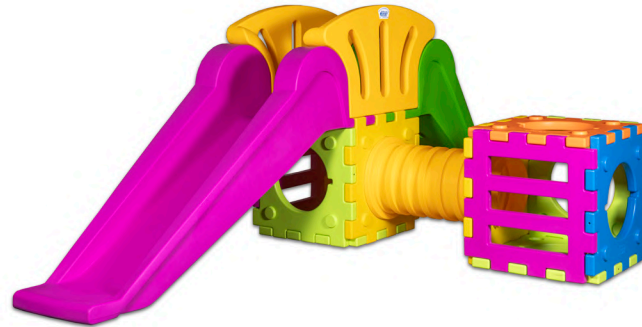

ART. 300

O2000

- 4 panels
- 1 large stairway
- 2 protective sides
- 2 ladder panels
- 1 large slide

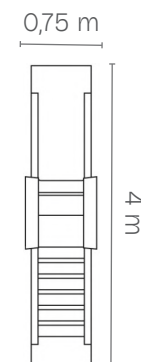

CUBIC TOY

ART. 157

H2000

- 14 panels
- 1 large slide
- 2 ladder panels
- 1 large stairway
- 2 protective sides
- 2 step-slides
- 2 tunnels
- 4 triangles
- 1 top section

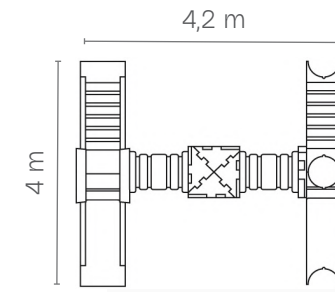
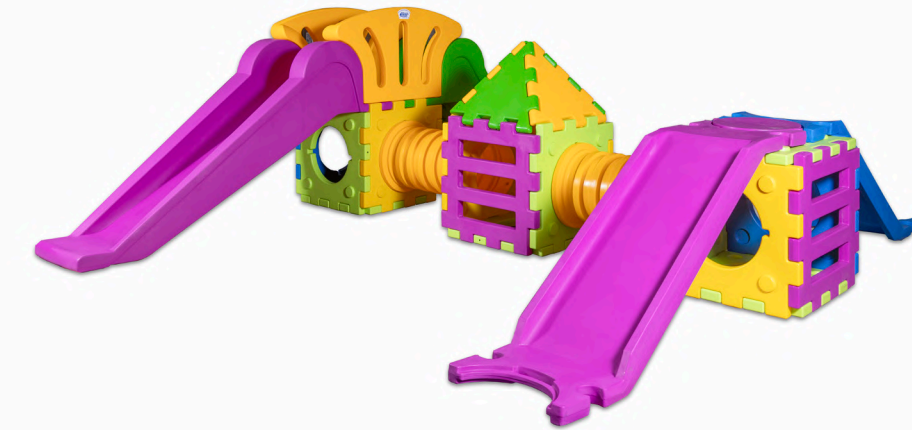

ART. 164

MODEL E

- 17 panels
- 2 tunnels
- 2 step-slides
- 4 triangles
- 1 top section

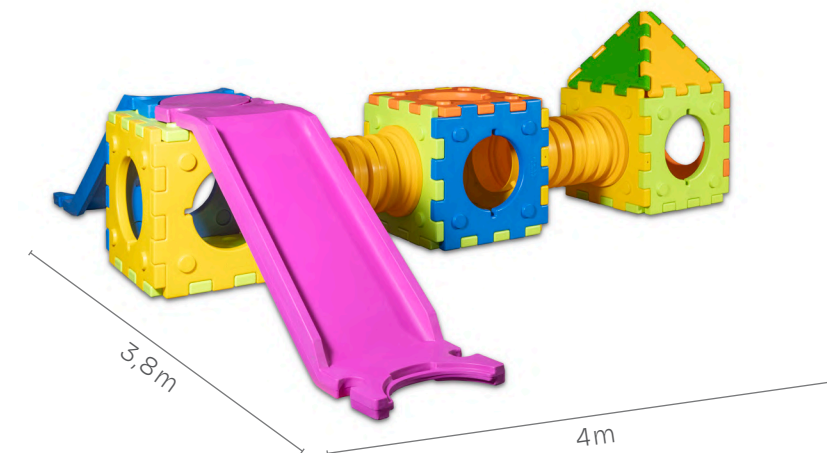

CUBIC TOY

ART. 297

QUADROTTO

- 8 panels hole Ø50 cm
- 16 panels hole Ø40 cm
- 4 tunnels Ø50 cm

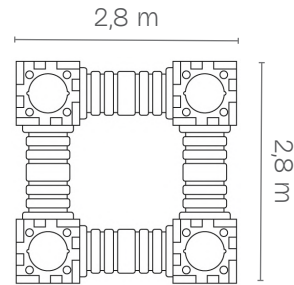
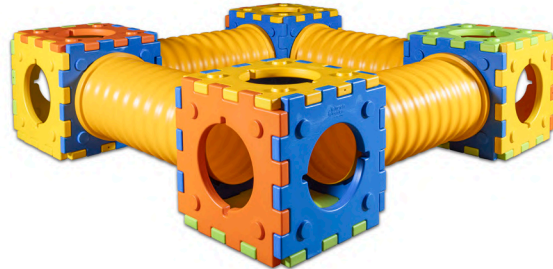

ART. 298

CASTLE A

- 8 panels hole Ø50 cm
- 12 panels hole Ø40 cm
- 4 tunnels Ø50 cm
- 16 triangles

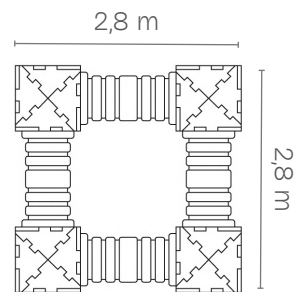

ART. 299

CASTLE B

- 8 panels hole Ø50 cm
- 14 panels hole Ø40 cm
- 4 tunnels Ø50 cm
- 8 triangles

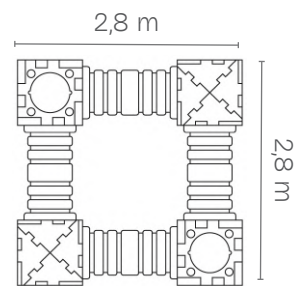

CUBIC TOY

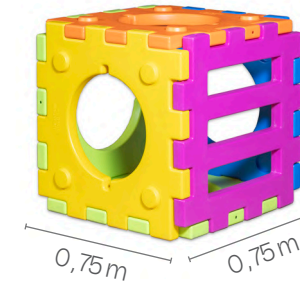

ART. 148

LADDER CUBE

- 5 panels
- 1 ladder panel

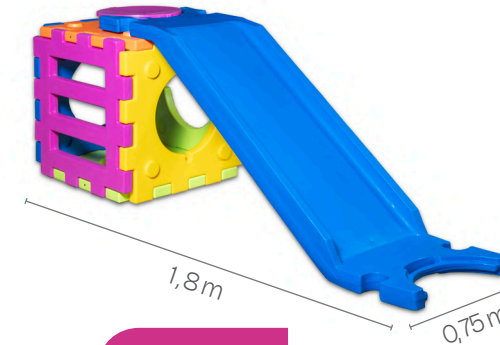

ART. 161

MODEL B

- 5 panels
- 1 ladder panel
- 1 step-slide
- 1 top section

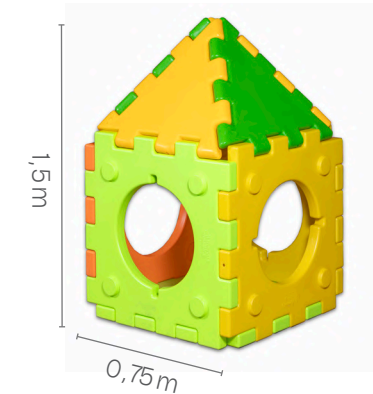

ART. 156

Cubic HOUSE

- 5 panels
- 4 triangles

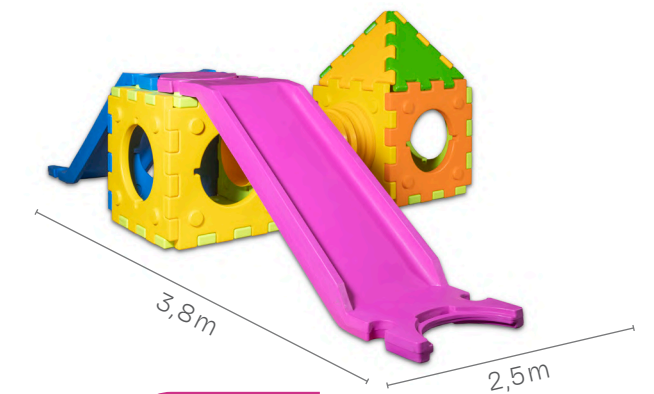

ART. 165

MODEL F

- 11 panels
- 1 tunnel
- 2 step-slides
- 4 triangles
- 1 top section

REPLACEMENT ELEMENTS

REPLACEMENT ELEMENTS

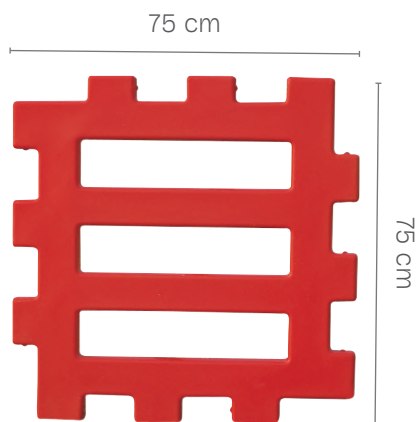

ART. 150

PANEL
ladder

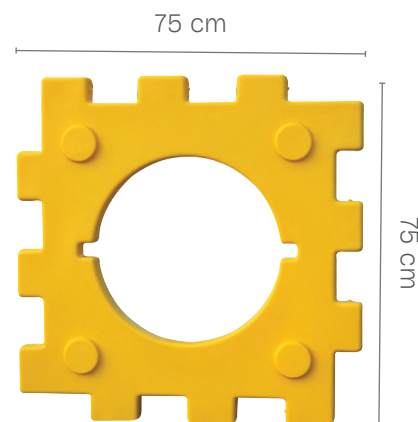

ART. 151

PANEL
Ø40 cm

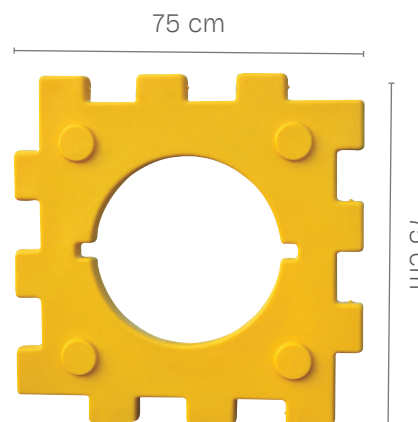

ART. 308

PANEL
Ø50 cm

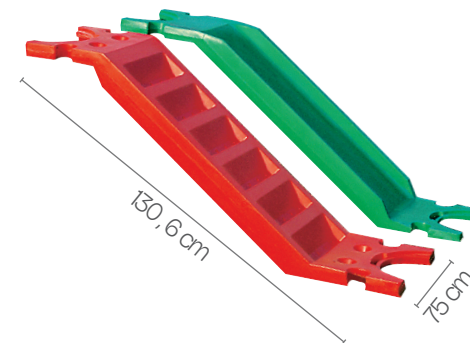

ART. 155

STEP-SLIDE

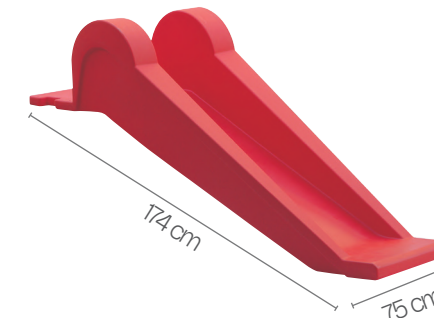

ART. 305

SLIDE
large

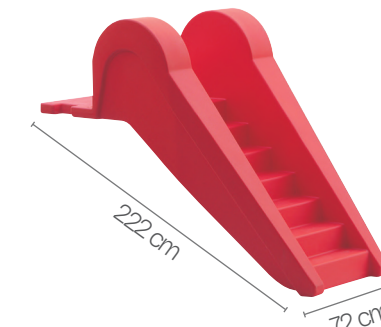

ART. 306

STAIRWAY
large

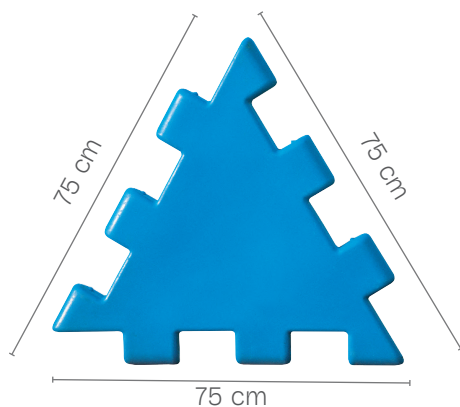

ART. 149

TRIANGLE
for roof

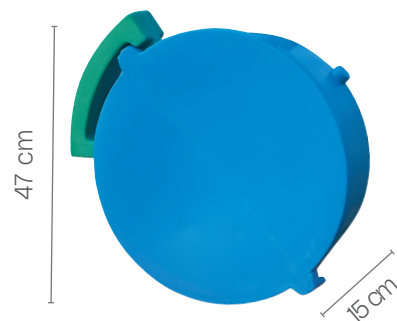

ART. 153

TOP SECTION

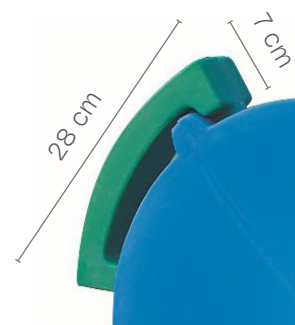

ART. 154

CONNECTOR

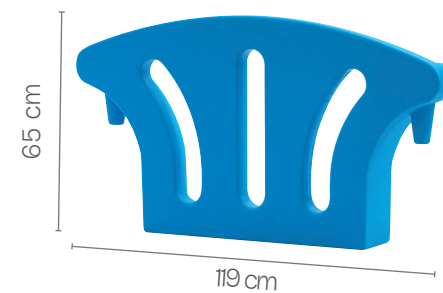

ART. 304

PROTECTIVE
SIDE

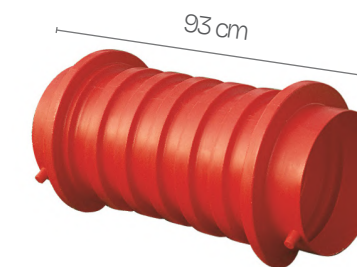

ART. 152

TUNNEL
Ø40 cm

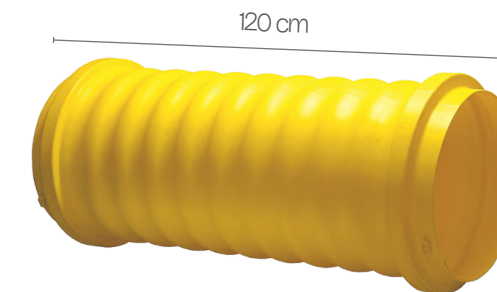

ART. 168

TUNNEL
Ø50 cm

Furniture

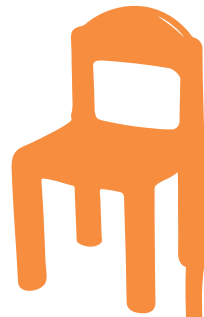

ART. 013

Nursery Plastic Chair



ART. 014

Kindergarten Plastic Chair



CHAIRS

The chair easily adapts to various environments thanks to its harmonious shape. It is made of **non-toxic, durable, high-quality plastic material** that ensures perfect **stability and solidity**.

The details are designed to make it safe and comfortable, and its exclusive contoured shape promotes correct **anti-slip seating**.

The height of the chair can be adjusted with a simple **replacement of the lower caps** .
(from 2 cm and 5 cm)

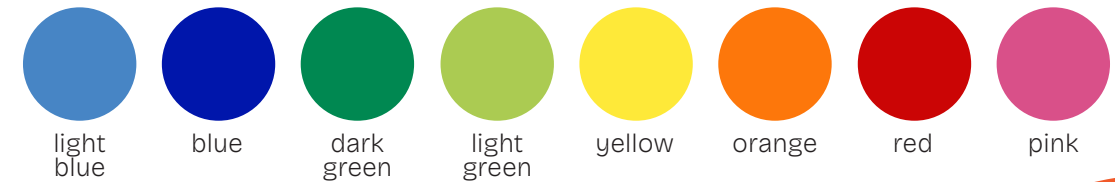

TABLES

Table made with a special structure featuring a white top in melamine-faced, anti-glare, and scratch-resistant fiberboard. The perimeter is edged with **soft, impact-resistant red Esaflex**, with rounded edges and corners.

The legs, made of polypropylene, are assembled to the top with 4 **corner joints**, making the table **solid and resistant** to any kind of pressure.

The height of the legs can be chosen between the **2 versions**:

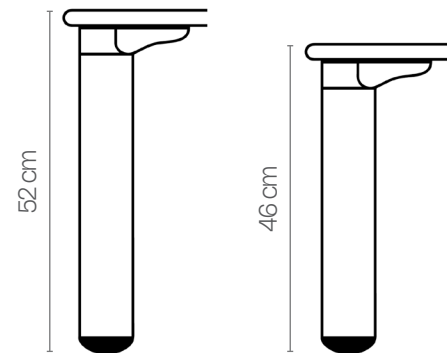

Patented corner joint

Assisted assembly technology

TABLES

ART. 015

Square table
65x65 cm



ART. 017

Circular table
Ø 80 cm



ART. 016

Rectangular table
130x65 cm



ART. 018

Hexagonal Table
lato 65 cm



EN
71-1/2/3
CE

CERTIFICATION

italveneta
didattica
a better play

COTS

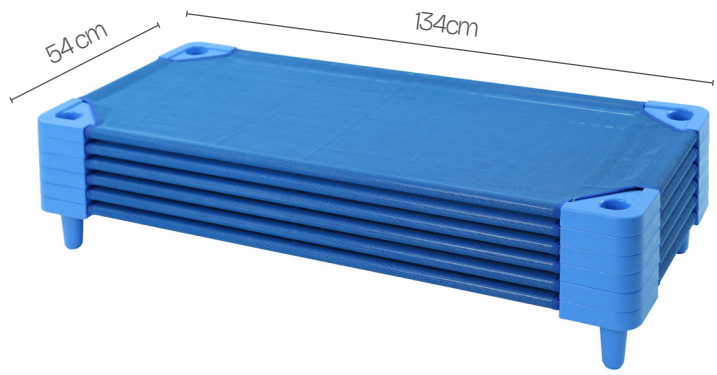

The fabric is made of **non-toxic material**, light blue in color, and **easily washable**. The cot is durable and comfortable to ensure the child's rest is safe; available in both assembled and disassembled versions, **easy to assemble**.

FEATURES

- Lightweight, stackable, and portable
- Durable and comfortable fabric
- Structure with oval anti-rust aluminum tubes
- Washable, breathable, and fire-resistant fabric
- Heat-sealed seams that prevent tearing
- One-piece structure without screws
- Rounded corners.



14cm

ART. 138
Assembled cot



UNI EN
1176-1/3
CERTIFICATION

FENCING

Modular, stable, and solid structure, ideal for creating fully enclosed play spaces or for **delimiting areas**. Suitable for indoor and outdoor use.

Made with high-quality and non-toxic material, the panels have **rounded shapes**, and thanks to the perfect and simple interlocking system, when positioned in a line, they remain **perfectly steady and fixed to the surface** without the use of anchors.

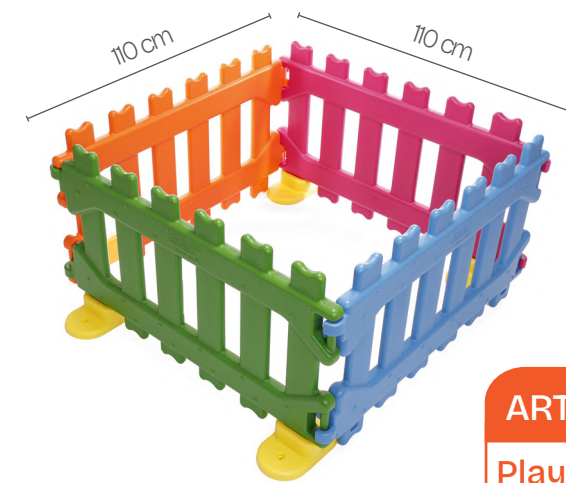

ART. 200
Play pen
• 4 panels (110x5x60h)
• 4 bases
Total length 4,40 m

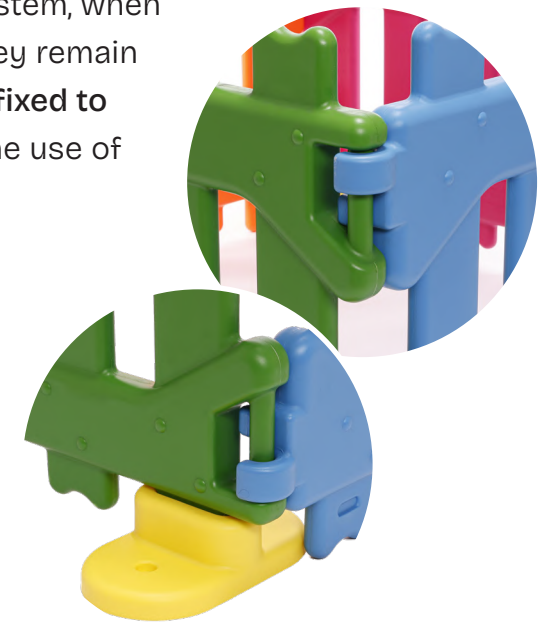

FLOORINGS

The anti-shock mat is an ideal protection for **indoor play areas**. The interlocking structure is easy to install, **requires no adhesive**, and can be cleaned with a damp cloth and mild detergent. It comes complete with **perimeter edging and corners**.

FEATURES

EVA Material (Ethylene Vinyl Acetate)

- Non-toxic
- Fire-resistant
- Water-repellent
- Mold and bacteria resistant
- Sound-absorbing



+A2
EN 71-1/2/3
EN 1177
CE
CERTIFICATION

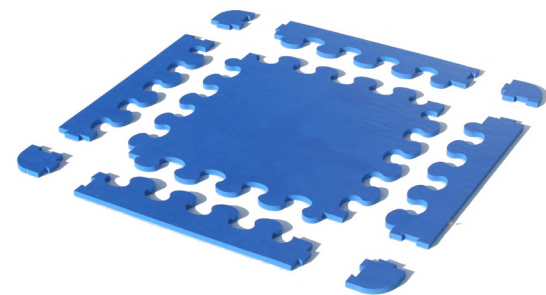

ART. 190

EVA flooring

50x50 cm
thickness 10 mm

ART. 191

EVA flooring

100x100 cm
thickness 10 mm

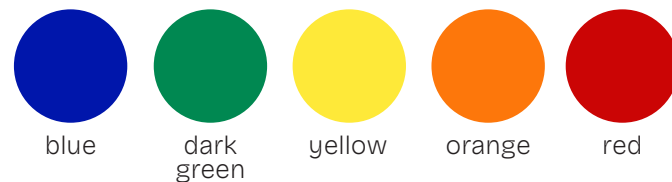

RADIATOR COVER

The **PVC radiator cover** is an essential tool for protecting children from radiators and convectors. **Available in various sizes** to meet different needs, the distance between the vertical tubes allows heat to pass through without children getting burned.

FEATURES

- Safe and **Fire-resistant**
- Non-toxic and **Free of sharp edges**
- Impact-resistant
- Easy to open for inspection and cleaning
- Stable thanks to **support brackets** that cannot be opened by children



UNI
10809 3.3
UNI 9177
CERTIFICATION

EN 71-9
19/07
CE
CERTIFICATION



ART. 196

Radiator cover

Ø 50 mm + 32 mm
distance 7 cm
thickness 2 mm

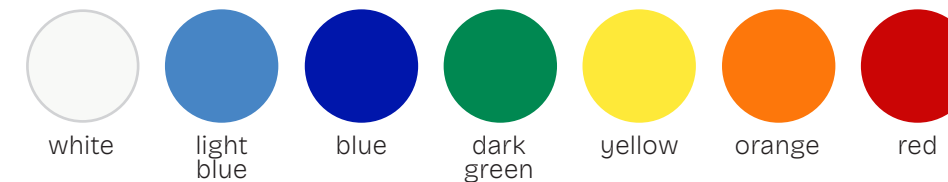

Psychomotricity



Psychomotor KITS

They stimulate coordination and movement games. They consist of gymnastic poles, flat hoops, pathway blocks, and balance beams. All kits are suitable for groups of various ages and allow the creation of balance courses with different levels of difficulty.

All parts are modular and perfectly compatible with each other, ensuring maximum flexibility of use. The solutions designed and suggested in the following images were created using all the components of the various kits, but it is possible to creatively create infinite courses.



UNI EN
71-1/2/3
CE
CERTIFICATION



ART. 102

KIT A

- 5 course blocks
- 4 bases with hole 25 mm
- 4 flat hoops (2 Ø50 cm, 1 Ø60 cm, 1 Ø65 cm)
- 12 gym poles l. 110 cm
- 2 cones h. 30 cm, 12 holes
- 2 jolly support clips
- 4 pole-pole clips

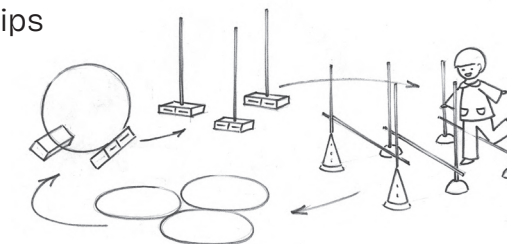

Psychomotor KITS



ART. 103

KIT B

- 5 gym poles l. 110 cm
- 9 course blocks + 24 suction cups
- 6 pole-flat hoop clips
- 8 flat hoops Ø65 cm
- 6 cones h. 30 cm, 12 holes
- 3 slats

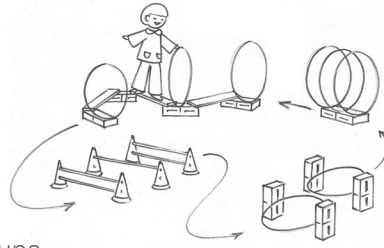

Course 1

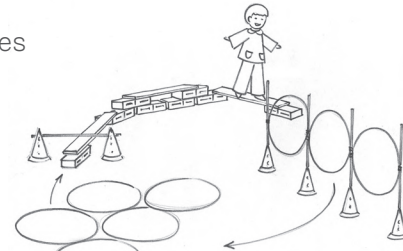

Course 2

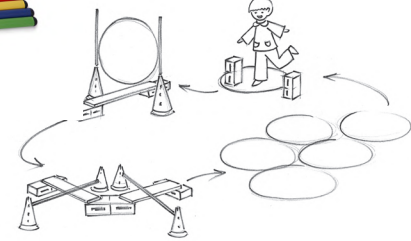

Course 3



ART. 104

KIT C

- set of motor tracks (6 hands + 6 feet)
- 7 flat hoops (5 Ø50 cm, 2 Ø65 cm)
- 2 pole-flat hoop clips
- 6 gym poles l. 110 cm
- 9 cones h. 30 cm, 12 holes

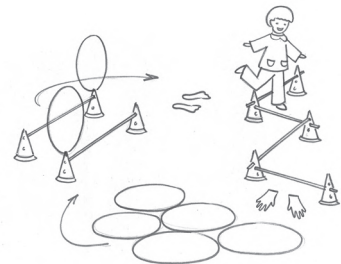

Psychomotor KITS



ART. 105

KIT D

- 2 gym poles l. 110 cm
- 10 course blocks + 24 suction cups
- 2 pole-flat hoop clips
- 2 flat hoops Ø65 cm
- 4 slats

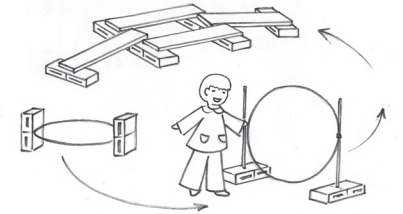

ART. 106

KIT E

- 13 course blocks + 40 suction cups
- 1 road sign ARROW
- 8 gym poles l. 110 cm
- 2 flat hoops Ø65 cm
- 2 cones h. 30 cm, 12 holes
- 4 jolly support clips
- 5 slats



Course 2

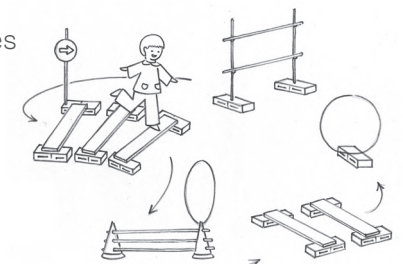

Course 1

UNI EN
71-1/2/3
CE

CERTIFICATION

Psychomotor KITS

italveneta
didattica
a better play

UNI EN
71-1/2/3
CE

CERTIFICATION

ART. 120

HOOP and POLE

- 8 flat hoops Ø30 cm
- 1 gym pole l. 60 cm
- 1 mega brick

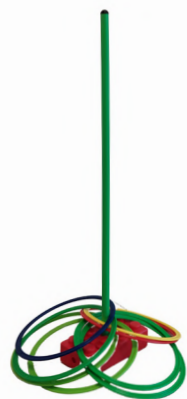

ART. 121

POLES's HOUSE

- 16 gym poles l. 120 cm
- 4 mega bricks
- 20 pole-pole clips



ART. 122

HOOP TUNNEL

- 3 flat hoops Ø65-70-80 cm
- 6 mega bricks



ART. 124

JUMP-JUMP

- 5 gym poles l. 120 cm
- 10 mega bricks



STILTS

Stilts develop **motor coordination** of the arms and legs.

The top part of the stilts is serrated for better foot grip and equipped with an **adjustable cord** that adapts to the child's height.

They are also available with **anti-slip rubber** perfectly inserted and interlocked in the lower part, allowing the child to play without slipping and **without making noise**.

ART. 141

Pair of stilts WITH

anti-slip rubber

ART. 142

Pair of stilts WITHOUT

anti-slip rubber



TUNNEL

The course consists of bases and arches that successively form a colorful tunnel where children can experiment with different games and skills, such as **spatial coordination** and the ability to navigate and **interact with other** children.

It can be used alone or as an **additional element** with other motor courses.



ART. 140

TUNNEL course

- 4 arches
- 8 bases



Designed to create courses in any environment thanks to the **soft Polymat base** for supporting children's knees.

The vortex tunnel helps to experience **tactile and visual sensations** and **develop motor skills** from the earliest months of the child's life.

ART. 144

Vortex TUNNEL

- 10 colored hoops
- 1 blue base 100x25 cm with 2 slots



SALTERELLO

ART. 094

LARGE SALTERELLO

- 12 gym poles (6 l. 70cm, 6 l. 80cm)
- 6 flat hoops Ø65 cm
- 6 cones h. 30 cm, 12 holes



ART. 095

SMALL SALTERELLO

- 9 gym poles (3 l. 60cm, 3 l. 70cm, 3 l. 80cm)
- 6 flat hoops Ø40 cm
- 6 cones h. 30 cm, 12 holes



ART. 096

LARGE MULTISALTERELLO

- 16 gym poles (8 l. 70cm, 8 l. 80cm)
- 8 flat hoops Ø50 cm
- 8 cones h. 50 cm, 12 holes

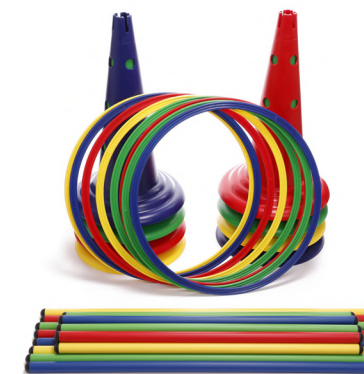

ART. 097

SMALL MULTISALTERELLO

- 20 gym poles (10 l. 60cm, 10 l. 80cm)
- 8 flat hoops Ø40 cm
- 8 cones h. 30 cm, 12 holes

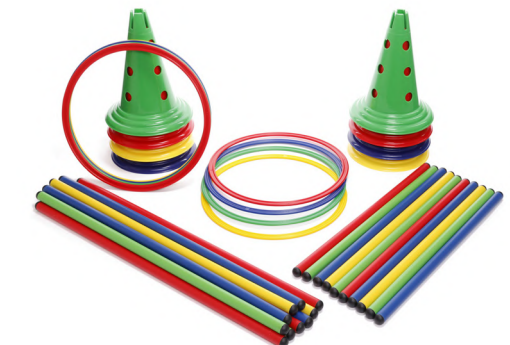

UNI EN
71-1/2/3
CE

CERTIFICATION

HURDLES

italveneta
didattica
a better play

Telescopic and tilting obstacle, made with **high-quality plastic tubing**, coloured, impact-resistant, and safe.



Adjustable height from 40 to 70 cm, with a **rubber-coated bar** to absorb impact in case of collision. Suitable for introducing young children to track and field. Available in yellow and fluo yellow.



ART. 174
JUMP hurdle



Telescopic



Tilting



UNI EN
71-1/2/3
CE

CERTIFICATION

COURSE BLOCKS

Stable blocks that **interlock with each other** to form different pathways and balance exercises. They help children gain greater confidence in their motor skills and practice **movement coordination**.

The block features a **serrated anti-slip texture** that protects the child from potential falls and helps them feel more secure.

ART. 059

Straight Pathway Block
Set of 10 assorted pieces in 4 colors

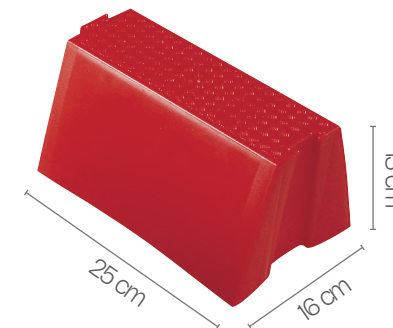

ART. 060

Curved Pathway Block
Set of 10 assorted pieces in 4 colors

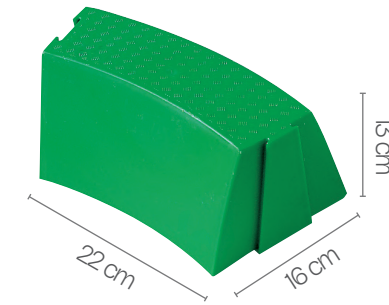

blue

dark green

yellow

red

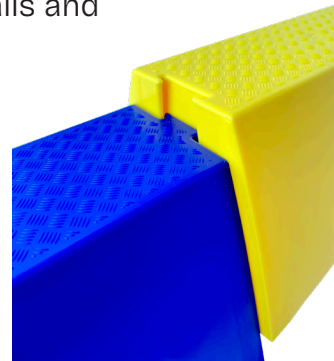

Interlocking system

SEMISPHERICAL COURSE

Composed of 12 straight bricks and 12 curved bricks with anti-slip serration, they are made in a semi-cylindrical shape to increase the level of difficulty, allowing the child to test and improve their balance and dexterity.

The elements interlock securely and stably, forming various and colourful paths.

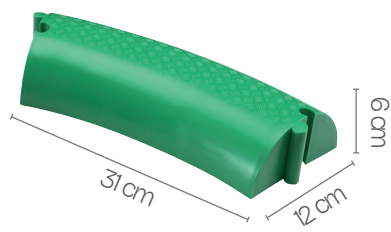
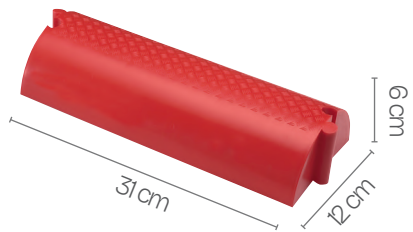

ART. 070

SEMISPHERICAL course

- 12 straight blocks
- 12 curved blocks



blue

dark green

yellow

red

BALANCE COURSE

The course is created with plastic slats and blocks made of plastic with holes and slots for inserting hoops or poles, and suction cups to adhere completely to any type of flooring.

With the various elements, it is possible to build different balance courses for spatial motor learning, with or without obstacles and different difficulties, adaptable to any age.

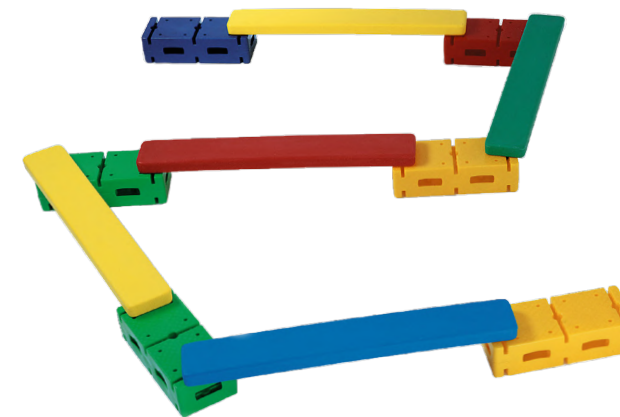

ART. 061

BALANCE course

- 5 plastic slats l. 75 cm
- 6 course blocks
- 24 suction cups

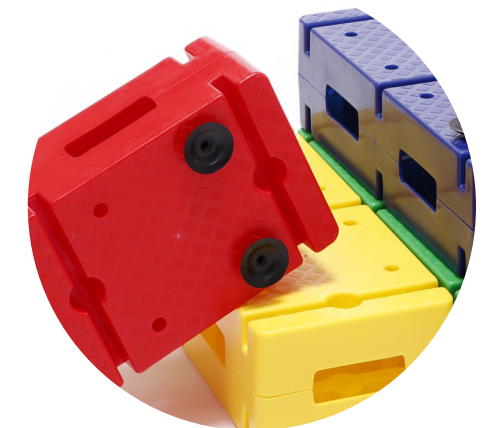

UNI EN
71-1/2/3
CE

CERTIFICATION

COURSE BLOCK

Course block made of plastic material with holes and slots for inserting flat hoops and poles with a section of 25 mm.

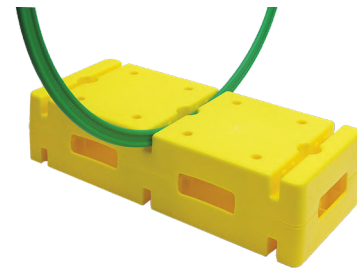
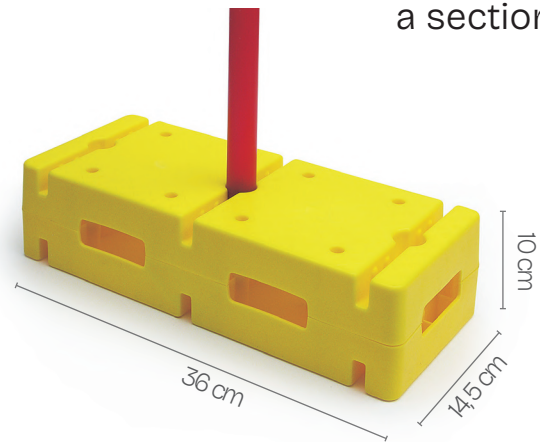

ART. 098

Course block
36 x 14,5 x 10 cm



ART. 099

SET 4 suction cups +
3 pins for each block



blue

dark green

yellow

red

italveneta
didattica
a better play

UNI EN
71-1/2/3
CE

CERTIFICATION

POLES

Made of plastic, impact-resistant, and safe; the ends of the gymnastic poles are closed with rounded anti-scratch caps.

Compatible with:
obstacle base (art. 109)
cones h. 30 and 50 cm.
Ø 25 mm.

ART. 072

Pole l. 50 cm

ART. 073

Pole l. 60 cm

ART. 074

Pole l. 65 cm

ART. 075

Pole l. 70 cm

ART. 076

Pole l. 80 cm

ART. 077

Pole l. 90 cm

ART. 078

Pole l. 100 cm

ART. 079

Pole l. 110 cm

ART. 080

Pole l. 120 cm

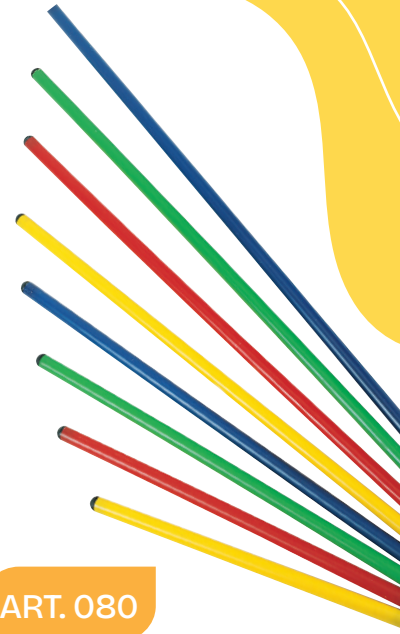

CLIPS

Universal joints for connecting poles and hoops of various sections (25 mm or 30 mm).



ART. 110

CLIP
support
jolly



ART. 111

CLIP
pole-pole
rotating



ART. 112

CLIP
pole-flat hoop
rotating

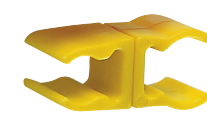
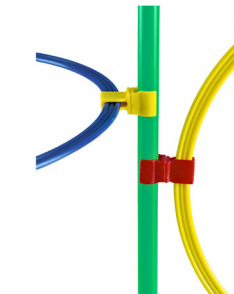

ART. 113

CLIP
pole-tubular hoop
rotating

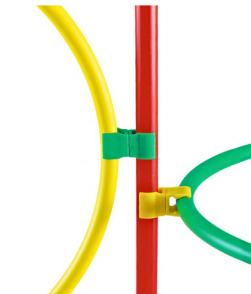

UNI EN
71-1/2/3
CE
CERTIFICATION

HOOPS

NYLON HOOP flat section

Durable hoops made of **high-quality flexible material** with **shape memory**, meaning they immediately return to their original shape.

ART. 081

Flat hoop Ø30 cm

ART. 082

Flat hoop Ø40 cm

ART. 083

Flat hoop Ø50 cm

ART. 084

Flat hoop Ø60 cm

ART. 085

Flat hoop Ø65 cm

ART. 086

Flat hoop Ø70 cm

ART. 087

Flat hoop Ø80 cm



TUBULAR section 20 mm

Lightweight, impact-resistant, and anti-scratch. Joined at the ends with an **internal pin**. Ideal for dance and rhythmic gymnastics.

ART. 088

Tubular hoop
Ø50 cm

ART. 089

Tubular hoop
Ø60 cm

ART. 091

Tubular hoop
Ø70 cm

ART. 092

Tubular hoop
Ø80 cm



Round section

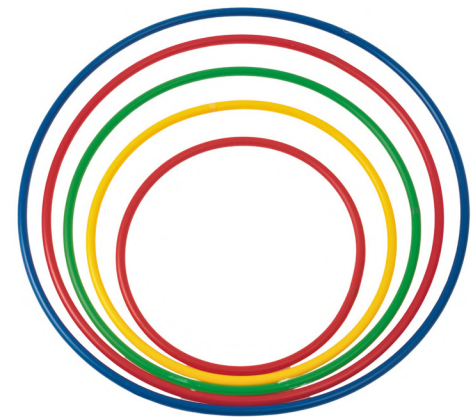

UNI EN
71-1/2/3
CE
CERTIFICATION

CONES

High-quality products with **cross-shaped grooves** at the top for inserting poles or hoops and **symmetrically drilled holes** on the sides for inserting poles at the desired height.



ART. 067

Cone without holes
h 50 cm

ART. 068

Cone with 3 holes
h 50 cm

ART. 069

Cone with 12 holes
h 50 cm

ART. 062

Cone without holes
h 30 cm

ART. 063

Cone with 3 holes
h 30 cm

ART. 064

Cone with 12 holes
h 30 cm



ART. 109

Spherical BASE
25 mm hole

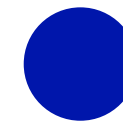

blue

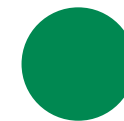

dark green



yellow

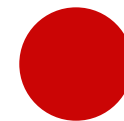

red

UNI EN
71-1/2/3
CE

CERTIFICATION

MARKERS

Markers are made of ultra-resistant, **non-toxic plastic material** with circular ribs. Ideal for delimiting **indoor and outdoor** areas in sports, and psychomotor activities.

They allow the creation of **training courses** for all ages and come with a practical collector.

ART. 198

Markers SET
48 pieces

ART. 199

Markers SET
24 pieces

ART. 404

MAXI markers
SET 24 pieces

ART. 405

MAXI markers
SET 12 pieces



10 cm

Ø20 cm



15 cm

Ø30 cm



TROLLEY

ART. 146

Psychomotor TROLLEY

115x50x90 cm

The trolley for psychomotor kits is made of **stable and solid wood**. On the side and top, it has a **hole for inserting long poles or rods**.

Features **4 wheels** for easier movement.



UNI EN
71-1/2/3
CE

CERTIFICATION

ART. 204

GYM KIT + Trolley

- wooden trolley
- 4 ropes of 2,5 m
- 2 pairs of mopen clubs of 155 gr
- 4 pairs of stilts without rubber
- 4 rhythmic gymnastics balls of 280 gr
- 8 sponge balls Ø 70 mm
- 4 sponge balls Ø 200 mm
- 4 gym poles l. 100 cm
- 4 course blocks
- 4 sets of 4 suction cups
- 4 flat hoops Ø 30 cm
- 4 flat hoops Ø 40 cm
- 4 flat hoops Ø 50 cm
- 4 flat hoops Ø 60 cm
- 4 cones h. 30 cm, 12 holes
- 20 assorted clips



UNI EN
71-1/2/3
CE

CERTIFICATION

Ball STORAGE

italveneta
didattica
a better play

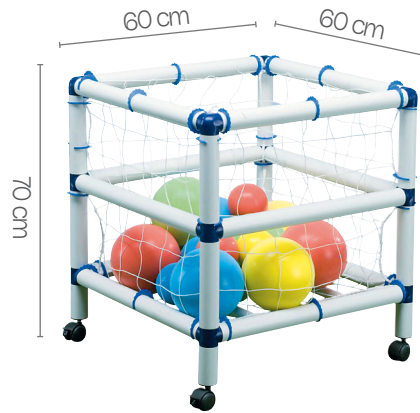

ART. 137

CONTAINER

made of plastic
holds 30/40 balls

Thanks to the **pivoting wheels**, it is easy to handle and move. Excellent capacity. Very robust. Made with Ø 50 cm tubing



ART. 210

RACK

made of plastic
holds 20/30 balls

Features **3 shelves** and is equipped with **4 pivoting wheels**. Made with impact-resistant, anti-scratch, and safe tubing.



ART. 492

TROLLEY

made of iron
holds 30/40 balls

Painted yellow, it has **4 wheels** and a **lock** with removable sides.

UNI EN
71-1/2/3
CE

CERTIFICATION

GOALPOSTS



Made with a structure in robust, impact-resistant, and safety plastic material, easy to assemble.

Complete with net, lightweight for transport but stable, with **rounded edges**.

Does not require ground anchoring and can be used outdoors as it is **weather-resistant**.

Suitable for games like soccer, rugby, and hockey.



ART. 169

Goalposts
DELUXE



ART. 171

Goalposts
ECONOMY



Gym ACCESSORIES

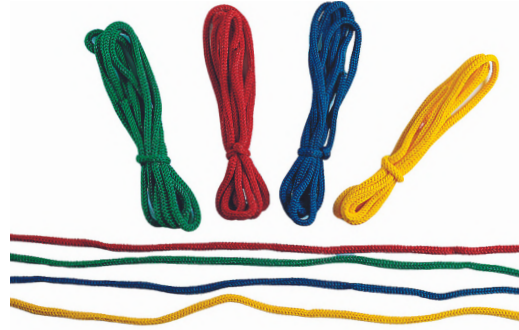

ART. 115

SET of 4 ROPES
of 2,5 m

ART. 116

SET of 4 ROPES
of 10 m with core

ART. 123

PAIR OF CLUBS

made of moplen
h. 45cm, 155 gr
assorted colors



ART. 143

Motor FOOTPRINTS

- 22 hands
- 22 feet



dark green

yellow

orange

red

SPONGE Articles



ART. 175

DICE

With contrast design
Side length 160 mm



ART. 178

BALL

Ø 120 mm
With contrast design



ART. 176

RUGBY BALL

With contrast design



ART. 180

BASKET BALL

Ø 170 mm
With contrast decoration



ART. 177

TENNIS BALL

Ø 70 mm
With raised decoration



ART. 181

SOCCER BALL

Ø 200 mm
With pentagon design

Recreational activities



BRICKS

The line of interlocking bricks is both a play tool and an educational aid.

FEATURES

- Safe and non-toxic
- Soft, impact-resistant plastic
- Bright and durable colours
- Various and modular shapes
- Variable dimensions

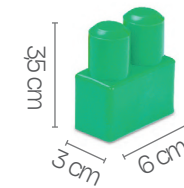
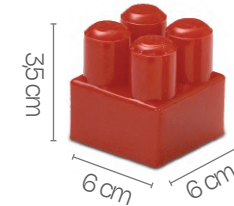
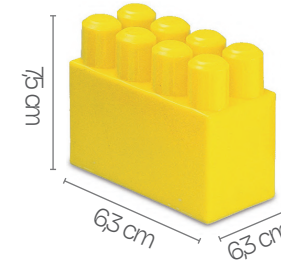

UNI EN
71-1/2/3
CE
CERTIFICATION

ART. 001

52 BRICKS

- 35 mini bricks mix of 2-4-8 studs
- 7 maxi bricks with 8 studs
- 2 pointed bricks
- 2 flat bricks
- 2 trains with wheels

ART. 002

30 BRICKS

- 21 mini bricks mix of 2-4-8 studs
- 4 maxi bricks with 8 studs
- 2 maxi bricks with 4 studs
- 1 pointed brick
- 1 flat brick
- 2 trains with wheels

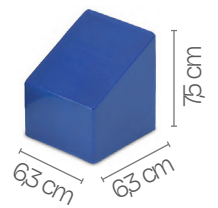
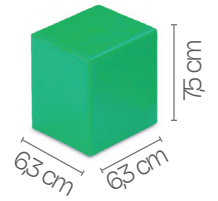

ART. 004

105 BRICKS

- 50 maxi bricks with 8 studs
- 24 maxi bricks with 4 studs
- 12 pointed bricks
- 12 flat bricks
- 7 trains with wheels

ART. 005

55 BRICKS

- 24 maxi bricks with 8 studs
- 12 maxi bricks with 4 studs
- 6 pointed bricks
- 6 flat bricks
- 7 trains with wheels

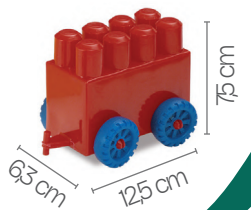

UNI EN
71-1/2/3
CE

CERTIFICATION

GIANT BRICKS

The giant brick is made of **durable, weightable and safe plastic**. It is a versatile game, easily assembled and can be used in courses for the child's psychomotor activities. The slots in the brick allow for easy, safe, and stable **interlocking of circles and poles**.

The brick can be used as a **giant construction**, ideal for encouraging the child's manual skills and creativity.

Its size is also **suitable for the very young**.



ART. 008

SET of 40
giant bricks

ART. 019

SET of 20
giant bricks



blue

dark green

yellow

red



italveneta
didattica
a better play

Mini BRICKS

Small coloured interlocking bricks, made of high-quality material in compliance with current regulations. Ideal for stimulating **creativity in compositions**.

FEATURES

- Noise-dampening material
- Safe and non-toxic
- Lightweight
- Handy



UNI EN
71-1/2/3
CE

CERTIFICATION



ART. 012

Container with 4 kg
of Bricks
(approx. 600 pcs)
includes lid

ART. 009

Bin with 2 kg of Bricks
(approx. 300 pcs)
includes lid Ø 37 cm



ART. 010

Toy CONTAINER
Made of **plastic and stackable**. Features rounded corners and **reinforcement ribs**.
Available in red.

3 STUDS:

12 studs

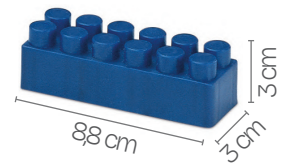

8 studs

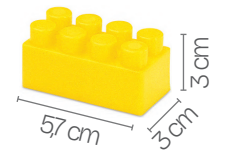

4 studs

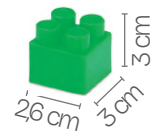

Manipulative BEADS

The beads are educational aids designed to help develop children's motor coordination and memory skills by training their minds to distinguish between shapes and colours.

They are available in various colours.



2 cm

ART. 020

200 ROUND
BEADS

including bin



3,1 cm

ART. 022

200 FLAT
BEADS

including bin

ART. 021

400 ROUND
BEADS

including bin

ART. 023

400 FLAT
BEADS

including bin



SAND Toys

Our sand toys are made of soft, non-toxic plastic that is resistant to sun and sand deformation. They maintain vibrant colours, have simple, spikeless shapes, and ergonomic grips for easy handling.



ART. 045

BUCKET

in plastic of 2 lt

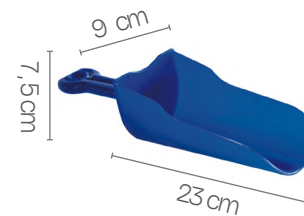

ART. 046

SHOVEL

in plastic

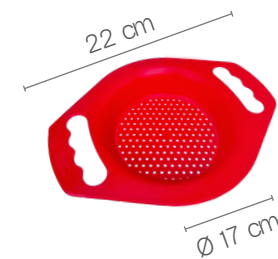

ART. 047

SIEVE

in plastic



blue

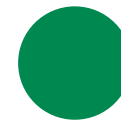

dark
green



yellow

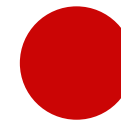

red



ART. 051

SET 20 MOULDS

assorted shapes and
colours



ART. 053

SAND KIT

- SET of 20 moulds
assorted shapes and
colours
- 4 buckets
- 4 shovels
- 4 sieves



ROAD SIGNS



Weighted spherical base



Practical and quick attachment



Screen-printed

Playing with road signs is **fun and very educational**: through play, children learn about danger signs, stop signs, and prohibition signs, as well as **traffic laws**, and they role-play as pedestrians, drivers, or police officers.

The **SETS** include:

- High-quality, anti-shock gymnastic rods
- Screen-printed signs
- Clips for easy attachment
- Weighted spherical bases



ART. 036

SET of 24 ROAD SIGNS

- 24 road signs with clips
- 12 poles l. 120 cm
- 12 bases

CIRCLE

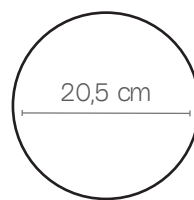

SQUARE

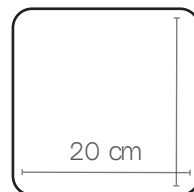

OCTAGON

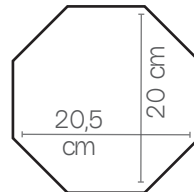

TRIANGLE

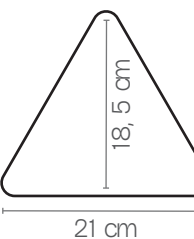

ROAD SIGNS

UNI EN
71-1/2/3
CE
CERTIFICATION

TRAFFIC LIGHT

Complete **with base and pole**.
Functional lights with manual or automatic cycle.
(Batteries not included)



ART. 202

Road safety education - KIT A

- 12 road signs with clips
- 1 traffic light with pole and base
- 6 poles l. 120 cm
- 6 bases

ART. 203

Road safety education - KIT B

- 12 road signs with clips
- 1 traffic light with pole and base
- 6 poles l. 120 cm
- 6 bases



Educational



CUISENAIRE RODS

The briefcase, made of **non-toxic plastic**, is divided into 10 compartments of different shapes and sizes to help the child with **space-dimension association**. Thus ordered, the cuisenaire rods **do not move inside** the briefcase, so if shaken, they do not make noise. The briefcase respects the colour scale, numbering from the smallest to the largest (1-10) and has an **easy pressure opening**.



The cuisenaire rods are **brightly coloured**, smooth to the touch, polished, and with rounded edges.

Furthermore, they are made of **solid material**, which makes even the smallest pieces indestructible and **muffles the noise** in case of a fall.

The child easily learns:

- **equivalences** (orange = 10 white)
- **numerical/colour associations**
- **first calculations** (red + green = yellow)

UNI EN
71-1/2/3
CE
CERTIFICATION

ART. 500

RODS CASE
original 186 pcs



ART. 506

RODS CASE
euro 200 pcs



UNI EN
71-1/2/3
CE

CERTIFICATION

MULTIBASE ABACUS

It helps the child tackle the **first notions of calculation** through the manipulation of beads. The beads and rods allow various games and operations that support children in **mathematical learning**

based on:

- **Quality:** develops awareness of counting and number positions
- **Quantity:** facilitates mathematical operations with bead manipulation.

FEATURES

- Recognizes **quantitative differences** between numbers
- Understands the meaning of **cardinal numbers**
- Achieves the first sequences, highlighting the meaning of **ordinal numbers**

ART. 512

MULTIBASE ABACUS
with case and instructions

ART. 037

SPARE ABACUS
40 beads
in nylon bag



UNI EN
71-1/2/3
CE

CERTIFICATION

LOGICAL SHAPES

italveneta
didattica
a better play



Teaching aids in plastic of **different thicknesses and sizes**. They are indicated for performing operations on set theory and for learning the **fundamental concepts of geometry**.

The logical figures help to **learn concrete and effective** fundamental concepts such as the distinction of shapes, colours, thicknesses, and set theory.

ART. 510

CASE with LOGICAL shapes
48 pcs of small sizes



ART. 513

TEACHING KIT

- 1 logical shapes case
- 1 multibase abacus case
- 1 cuisenaire rods case 200 pcs
- explanatory book "using the rods"

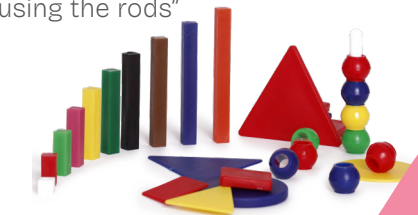

Hobby



CRYSTAL

Transparent plexiglass items, known as crystal, combine aesthetics and practicality to offer endless creative possibilities. The flawless, **crystal-clear finish** adds a touch of elegance and brightness to any project, making them ideal for event decorations, shop window displays, and refined design details.

Each shape **can be opened**, allowing small objects, details, or decorations to be placed inside, making the creation even more personalized and captivating.

Additionally, thanks to the practical **integrated hook**, these items can be easily hung.



STAR



EGG



DROP



BALL



HEART



MEDALLION

FEATURES

- Crystal-clear transparency that enhances colours and textures
- **Durable and lightweight** material
- **Opening** that allows the insertion of decorative elements
- **Hook** for easy hanging

ART. 8189

to

ART. 8212

POLYSTYRENE

Polystyrene items are available in a **wide variety of shapes and sizes**, making them an ideal solution for creative projects, DIY crafts, and decorations. From schools to professional environments, these products provide a **solid and versatile base** for educational and recreational activities.

The quality of **pressed polystyrene** ensures unique compactness, while the absence of colorants guarantees a pure and safe material, suitable even for young children.

Perfect for window display designers, florists, and creative associations, polystyrene items allow for the creation of **customized settings**.

FEATURES

- **Non-toxic material**
- **Colorant-free** to ensure safety and purity
- **Compactness** due to pressed molding

ART. 9001 to ART. 9301



POLYSTYRENE set



ART. 9200

SPRING SET

- 5 apples
- 2 sunflowers
- 1 clock sun
- 1 sun
- 1 flower vase



ART. 9201

EASTER SET

- 7 ducks h. 10cm
- 4 eggs h. 6/10cm
- 2 bells h. 8cm
- 2 full wreaths Ø125/180cm
- 2 flat wreaths Ø125/180cm
- 2 chicks
- 1 rooster to hang



ART. 9202

CHRISTMAS SET

- 5 balls Ø60cm
- 4 balls Ø80cm
- 4 full wreaths Ø125/180cm
- 4 flat wreaths Ø125/180cm
- 2 large stars
- 1 candlestick



ART. 9203

ANIMALS SET

- 3 penguins
- 2 large swans
- 2 small fishes
- 1 large Dalmatian dog
- 1 elephant
- 1 snail





Italteneta Didattica



(+39) 351 525 5621
(+39) 042 630 8348

italveneta_didattica



www.italvenetadidattica.com

Italteneta Didattica S.R.L.



info@italvenetadidattica.com



Via Risorgimento No. 32, Pegolotte di
Cona, Venice, 30010, Italy

italveneta
didattica
a better play